

DC AXIAL FAN 92x92x38mm (Stator Outlet Blade)



Housing/Blade: Thermoplastic PBT, UL 94V-0
 Insulation Resistance: 10MΩ, 500VDC/min between bare wire and frame
 Dielectric Strength: 5mA max. 500VAC/min between bare wire and frame
 Operation Temperature: -20°C~70°C(Humidity 15%-90%RH)
 Storage Temperature: -40°C~85°C(Humidity 15%-90%RH)
 Lead Wire: UL Type #24 AWG
 Weight: 230 g Packing: 60PCS/CTN



- High Airflow
- Extremely High Static Pressure



DC Axial Fans

Model Number	Voltage (VDC)	Op.Voltage (VDC)	AirFlow (CFM)	StaticPres. (mm-H ₂ O)	Noise (dBA)	Speed (RPM)	Current (mA)	Power (W)	Available Bearing	Curves
FD9238B12W3-85	★▲ 12	6.0~13.8	131.30	27.20	54.20	6,200	1,500	18.00	B	①
FD9238B12W5-85	★▲ 12	6.0~13.8	159.80	39.10	58.10	7,500	2,300	27.60	B	②
FD9238B12W7-85	★▲ 12	6.0~13.2	193.40	53.00	64.00	9,000	4,000	48.00	B	③
FD9238B24W3-85	★▲ 24	16.0~27.6	131.30	27.20	54.20	6,200	670	16.08	B	①
FD9238B24W5-85	★▲ 24	16.0~27.6	159.80	39.10	58.10	7,500	1,150	27.60	B	②
FD9238B24W7-85	★▲ 24	16.0~27.6	193.40	53.00	64.00	9,000	2,000	48.00	B	③
FD9238B48W3-85	★▲ 48	30.0~55.2	131.30	27.20	54.20	6,200	360	17.28	B	①
FD9238B48W5-85	★▲ 48	30.0~55.2	159.80	39.10	58.10	7,500	550	26.40	B	②
FD9238B48W7-85	★▲ 48	30.0~55.2	193.40	53.00	64.00	9,000	950	45.60	B	③

- If model depicts "★", auto restart protection function built in.
- If model depicts "▲", polarity protection function built in.

Specifications are subject to change without notice

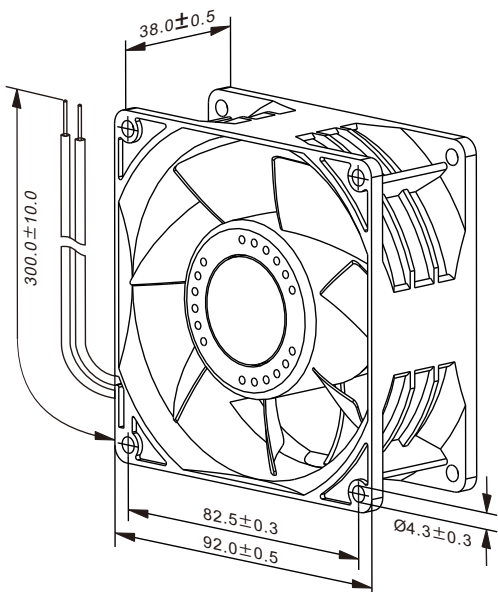

unit: mm

