

AC AXIAL FAN 180x180x90mm



Housing: Die-Cast Aluminum, Painted Black
Blade: Injection Molded of Flame Retardant Polycarbonate, Black
Insulation Resistance: 100M Ω , 500VDC/min between bare wire and frame
Dielectric Strength: 1500VAC for one minute
Operation Temperature: -20°C~70°C(Humidity 35%-85%RH)
Storage Temperature: -40°C~85°C(Humidity 35%-85%RH)
Motor Protection: Thermally Protected
Weight: 1600 g **Packing:** 8PCS/CTN

Model Number	Voltage (VAC)	Frequency (Hz)	AirFlow (CFM)	Stat.Pres. (mm-H ₂ O)	Noise (dBA)	Speed (RPM)	Current (mA)	Power (W)	Available Bearing	Curves
FA1890B11T7C-51	115	50/60	376.0/409.0	16.3/17.1	58.0/61.0	2,800/3,000	470/660	55/77	B	①/②
FA1890B22T7C-51	230	50/60	378.0/434.0	16.3/17.1	58.0/62.0	2,800/3,200	250/330	58/76	B	①/②

• For "Wire Lead" version, change the "T" in the model number to "W".

Specifications are subject to change without notice

AC Axial Fans

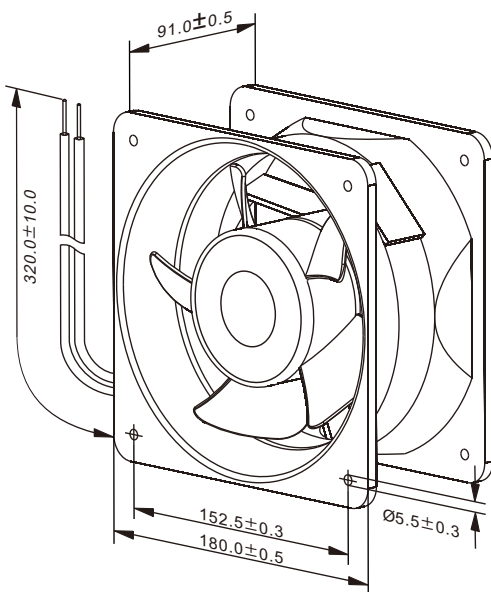

unit: mm

