

Standards and Specifications of Model: FD6038B24W9-87-4JC1 (PWM + Speed Sensor + Auto Restart Protection)



A. General Specification

Item		Specification / Standard / Condition	
01	Outline Dimension	60 x 60 x 38	mm
02	Bearing	Dual Ball Bearing	
03	Rated Voltage	DC	24 V
04	Operating Voltage	DC	14.0 V ~ DC 26.4 V
05	Starting Voltage	DC	14.0 V (At 25°C, Power ON / OFF)
06	Rated Current (Max.)	0.87	A
07	Actual Current	0.80	A
08	Power Consumption	19.2	W (Max.: 20.88W)
09	Rated Speed	12,000	RPM ± 10%
10	Max. Air Flow	67.30	CFM
11	Max. Static Pressure	52.60	mm-H ₂ O
12	Noise Level(AVG.)	62.00	dB(A)
13	Life Expectancy	70,000	Hrs at 40°C
14	Net Weight	145	Gram
15	Number of Blade	7	Blades
16	Number of Pole	4	Poles
17	Rotating Direction	Counter-Clockwise	Looking at Rotor Side
18	Material:	Housing: Plastic UL 94V-0 P.B.T. Blade: Plastic UL 94V-0 P.B.T.	
19	Lead Wire	UL Type #28 AWG, 76.2mm	Red: (+) Black: (-) Yellow:(Speed Sensor) Blue: (PWM)
E	Connector	With equivalent Molex # 0022013047& 08-50-0114	
21	Special Function	PWM + Speed Sensor + Auto Restart Protection	

B. Electrical Specification

Item		Specification / Condition	
01	Locked Rotor Protection	✓	Safety Condition
		✓	a. Auto power off after locked at rated voltage for 1 sec. b. After auto power off, circuit attempt to restart in a few seconds.
02	Polarity Protection	✓	Circuit is protected when VCC & GND are exchanged, the circuit won't be burned within 5 seconds.
03	Insulation Resistance	✓	10m.Ohm / between unshielded wire and frame at 500 VDC/min.
04	Dielectric Strength	✓	5mA Maximum. / Measured between lead wire (+) and frame at 500 VAC/min.

C. Environmental Specification

Item		Specification / Condition
01	Operating Condition	Temperature: -10°C ~ + 70°C
		Humidity: 5% ~ 90% RH
02	Storage Temperature	Temperature: -40°C ~ + 75°C
		Humidity: 5% ~ 95% RH

D. Safety Approvals



Safety Approval	File No.
CE	TB10088262

E. Label Marking

01: Fan Label Marking

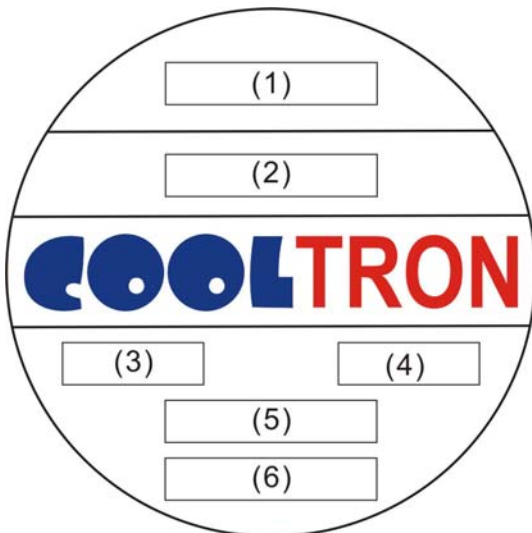

(1)	Safety Approval
(2)	Model Number & Appendix Code
(3)	Rated Voltage
(4)	Power Consumption
(5)	Bearing Type
(6)	Location

02: RoHS Label Marking:



Label	Location
RoHS & Date Code	Fan Outlet Frame

F. Air Flow Performance Curve

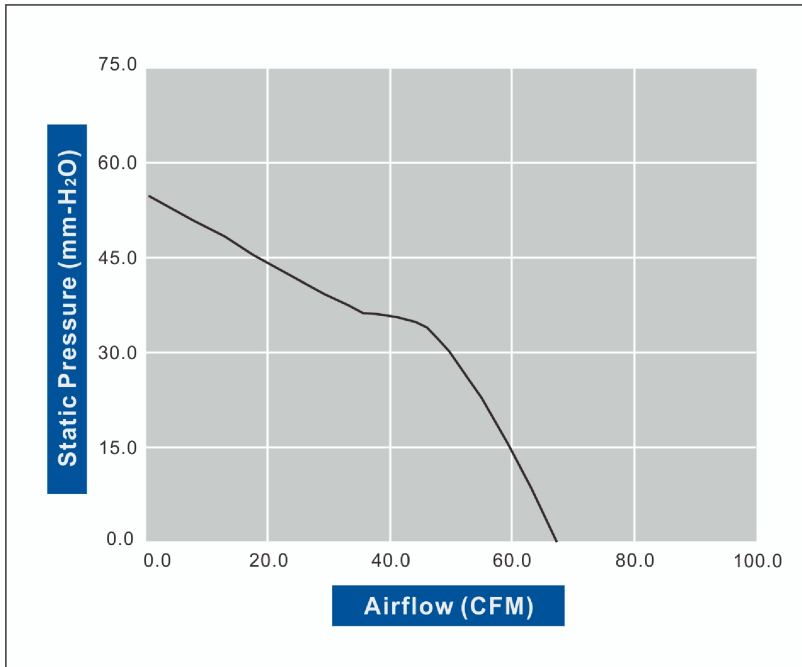

G. Model Drawing

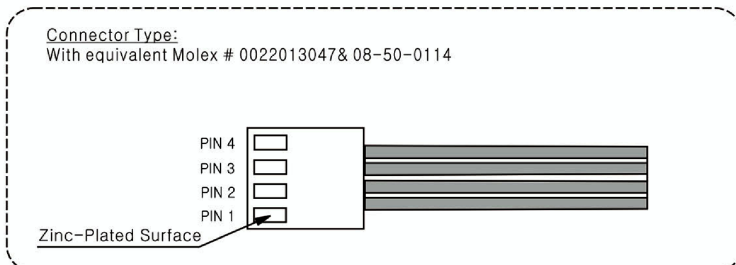
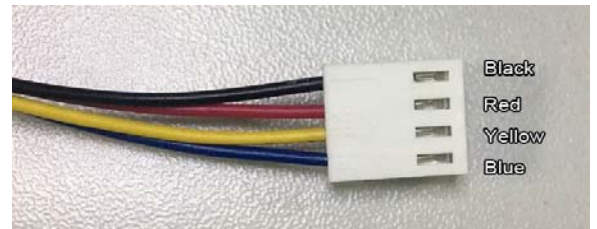
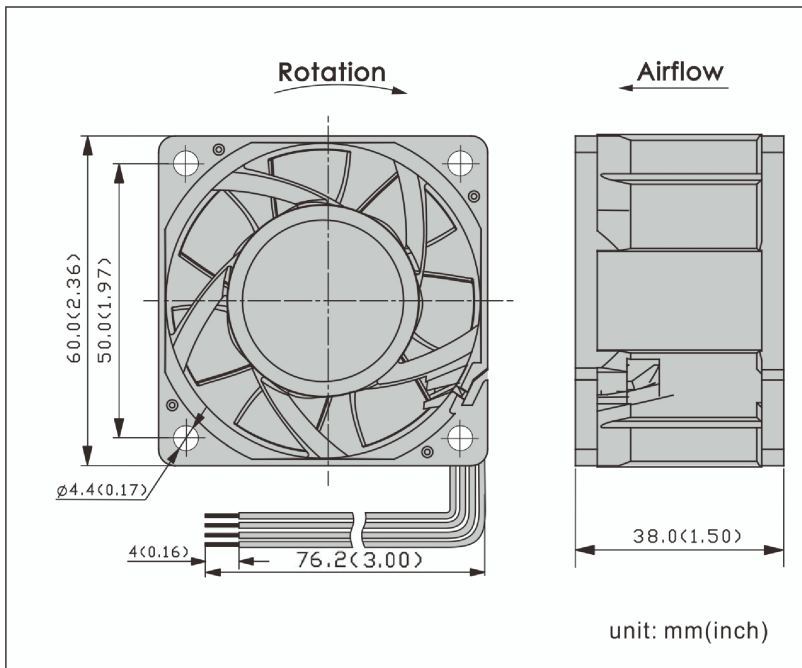

H. Fan Photos



FD6038-87



I. Sensor Circuit System:

Speed Sensor w/Auto restart

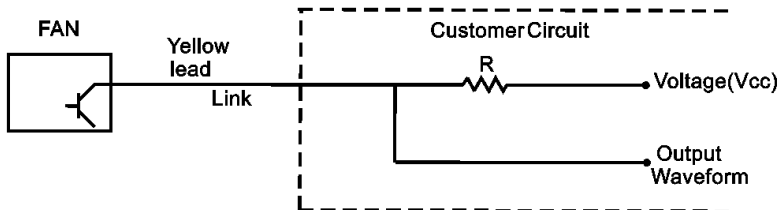

** Please select "R" to make "Link" less than 10mA * Vcc:30V MAX, Link:10mAMAX

Output Waveform

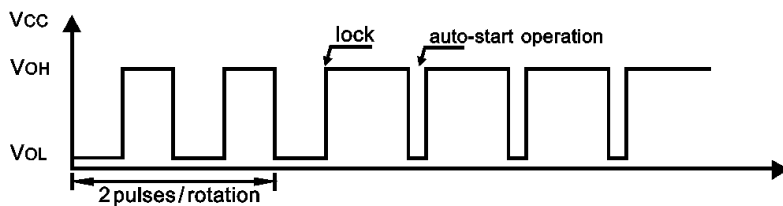

J. PWM CONTROL

I. SIGNAL DESCRIPTION

1. CONTROL SIGNAL: PWM CONTROL
2. SIGNAL TYPE:
INPUT HIGH LEVEL VOLTAGE: MIN. >2.6V , MAX.<5V
INPUT LOW LEVEL VOLTAGE: MAX.<0.5V
3. PWM FREQUENCY RANGE: 100HZ~100KHZ
4. MAX. SINK CURRENT: 8mA

II. FAN SPEED CONTROL

1. INPUT VOLTAGE: 5 VDC
2. PWM FREQUENCY : 25 KHZ
3. THE FAN SPEED SHOULD RUN AT FULL SPEED GIVEN PWM 100% DUTY CYCLE INPUT.
4. THE FAN SPEED SHOULD RUN AT ZERO SPEED GIVEN BELOW PWM 0 % DUTY CYCLE INPUT.
5. THE FAN WILL GO TO FULL SPEED WHEN IF THE CONTROL SIGNAL IS DISCONNECTED.

PWM DUTY VS RPM CURVED VS PWM CONTROL CHART.

Duty (%)	25%	50%	75%	100%
Speed R.P.M (REF)	4200± 20%	7400 ± 20%	10000± 10%	12000±10%

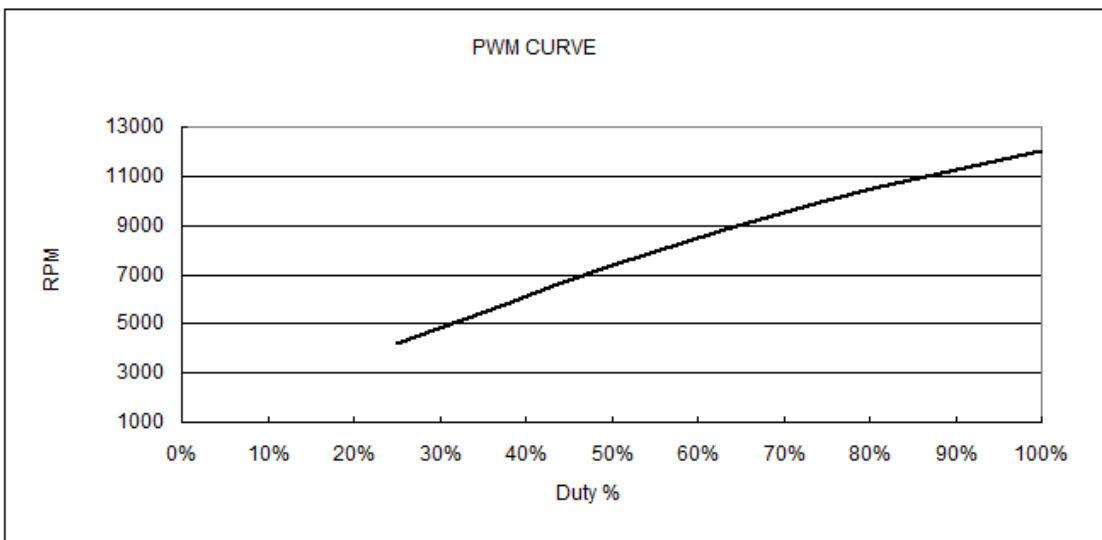

REMARKS

1. COOLTRON will not assume responsibility for the performance of the products if the application conditions fall outside the parameters stated forth in this specification.
2. A written request should be submitted to COOLTRON prior to approval if abnormality and deviation from this specification is required.
3. Please be cautious when fan is being exercised or handled. Damages may be resulted when apply pressure to the impeller or hold the fan by the lead wires or drop the fans to the production platform.
4. With exception of suitability of some particular designs, any failure and problems regarding safety of the product caused by the introduction of powder, droplets of water or encroachment of insert in the hub are not guaranteed.
5. All general specifications and quality values are measured under condition of free air and fan vertical set up. COOLTRON highly suggests practicing a test when fan apply to a special application.
6. COOLTRON fans are not suitable to be used in an environment that contains aggressive or corrosive fluids.
7. Always ensure that fans are stored according to the storage temperatures specified. Do not store in an environment with a high humidity level. If the fans were stored for longer than 6 months, it is highly recommended to apply functional testing before shipping.
8. Except for the feature of the Lock Rotor Protection specifically stated, this feature is not applied to all fans. COOLTRON highly suggests not to stop the impellers of the working fans such interruption will cause adverse effect.
9. During installation, please be cautious. COOLTRON is not responsible for any excess resonance, vibration and subsequent noise caused by incorrect mounting of fans.
10. During testing it is important to consider safety at all times. A suitable guard should be fitted to the fan to prevent personal injury.
11. All test environments are conducted under the condition of relative (ambient) temperature and humidity at 25°C, 65%RH. The test result stated above is effective only for unique fan performance.
12. The above conditions are examples of extreme application. However they are very important and should receive top priority.